

KLT-T3MPF-AR0144 V1.0

**1MP OnSemi AR0144CS Global Shutter DVP Parallel and MIPI Interface
Fixed Focus Camera Module**



Front View



Back View

Specifications

Camera Module No.	KLT-T3MPF-AR0144 V1.0
Resolution	1MP
Image Sensor	AR0144CS Global Shutter
Sensor Type	1/4"
Pixel Size	3.0 um x 3.0 um
EFL	3.29 mm
F.NO	2.80
Pixel	1280 x 800
View Angle	68.7°(DFOV) 58.1°(HFOV) 45.0°(VFOV)
Lens Dimensions	8.50 x 8.50 x 4.90 mm
Module Size	24.00 x 9.00 mm
Module Type	Fixed Focus
Interface	DVP Parallel and MIPI
Auto Focus VCM Driver IC	None
Lens Model	KLT-LENS-M5101
Lens Type	650nm IR Cut
Operating Temperature	-40°C to +85°C
Mating Connector	DF30FC-40DS-0.4V

**KLT-T3MPF-AR0144 V1.0****1MP OnSemi AR0144CS Global Shutter DVP Parallel and MIPI Interface
Fixed Focus Camera Module**

Top View

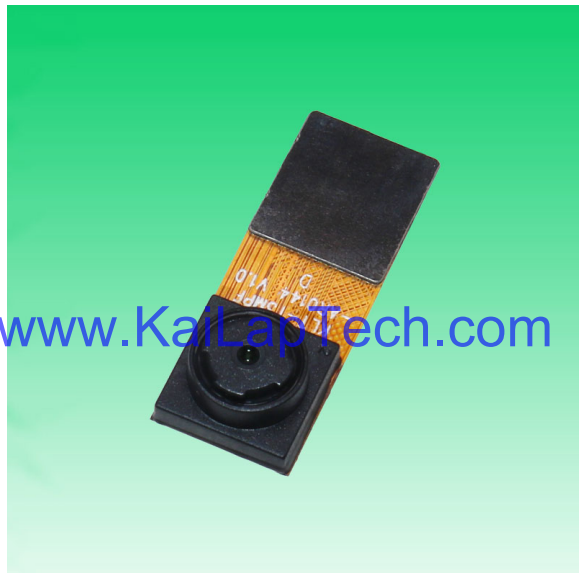

Side View

www.KaiLapTech.comwww.KaiLapTech.com

Bottom View



Mating Connector

Version	Information	Date
V1.0	First Version	4-25-2020

RoHS	
PIN	SIGNAL
P1	DATA1_P
2	DATA1_N
3	DGND
4	DVDD1.2V
5	DVDD1.8V
6	AVDD2.8V
7	DATA2_P
8	DATA2_N
9	AGND
10	CLK_P
11	CLK_N
12	DGND
13	RESET_BAR
14	SADDR
15	DGND
16	EXTCLK
17	SDATA
18	SCLK
19	FLASH
20	PIXCLK
21	DGND
22	DOU0
23	DOU1
24	DOU2
25	DOU3
26	DOU4
27	DOU5
28	DOU6
29	DOU7
30	DOU8
31	DOU9
32	DOU10
33	DOU11
34	TRIGGER
35	SHUTTER
36	LINE_VALID
37	FRAME_VALID
38	NC
39	NC
40	NC

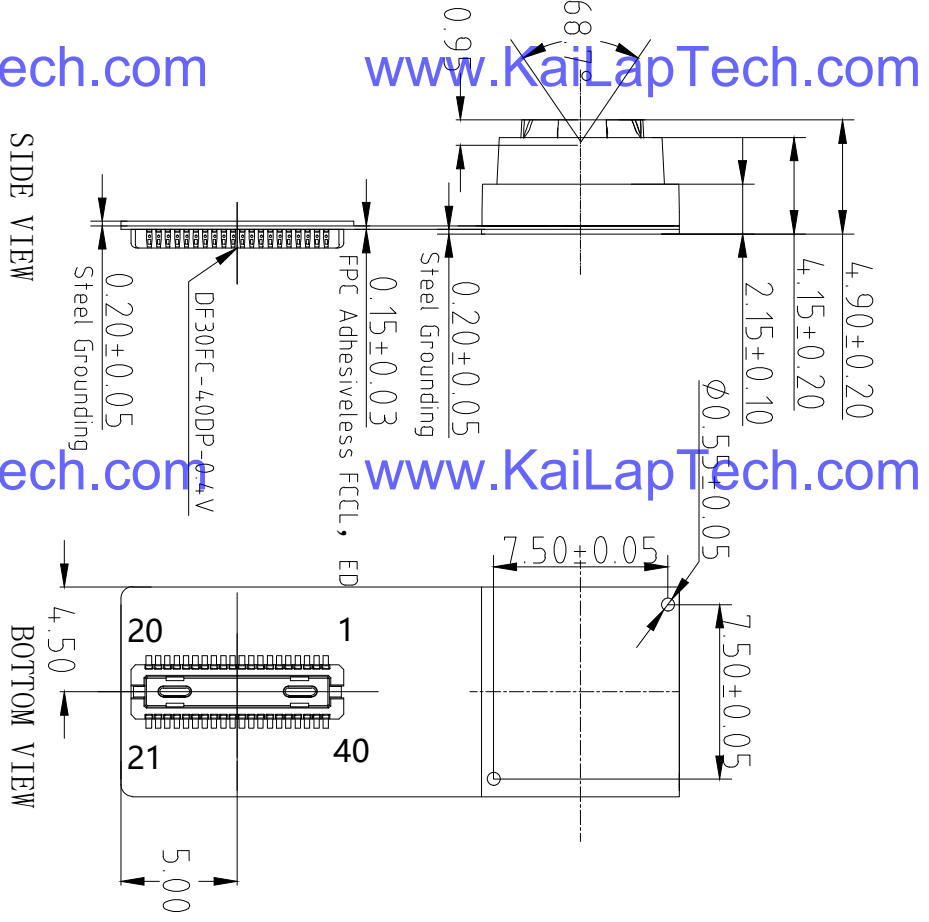
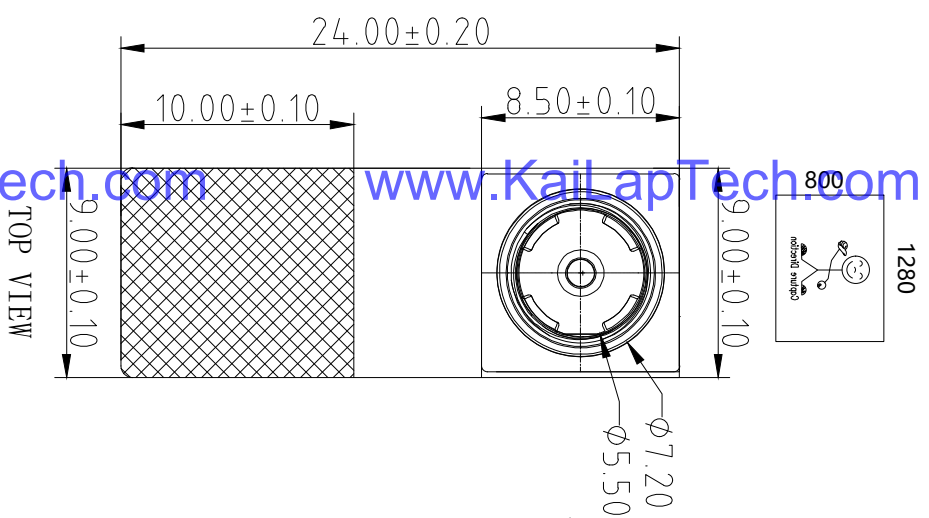

NOTE:
 1.Sensor I2C slave address:0x20 If SADDR=0;
 or 0x30 If SADDR=1

Parameters:

1. Sensor specification:

Image Sensor: AR0144(CSSCC20SUKA0-CRBR)
 Pixel: 3umx3um
 Lens Type: 1/4
 Important Voltage Description: DVDD1.2V (external power supply);

2. Lens specification:

FOV: 68.7°(D);58.1°(H);4.5°(V)
 F/NO: 2.8
 TV Distortion: <1.0%
 Focal length: 3.29mm
 Composition: 4P+IR FILTER
 IR Cut Coating: 650nm±10nm@50%

Kai Lap Technologies Group Ltd

Designed By Kevin

Checked By Aoulyan

Model Name: KLT-T3MPF-AR0144 V1.0

Projection Type: Third Angle
 Unit: mm
 Material: -----
 Scale: 1:1
 Sheet: 1 of 1
 Version: 1/0

3

3

2

2

1

1

Lens Model: KLT-LENS-M5101

SPECIFICATION		
1. SENSOR SIZE	1/4" (5M CSP)	
2. MAX IMAGE CIRCLE	24.90mm	
3. TOTAL TRACK	4.18±0.1mm	
4. EFL	3.29mm	
5. OPTICAL BFL	1.43mm	
6. MECHANICAL BFL	0.85mm	
7. F/NO	2.8±5%	
8. VIEW OR FIELD	VERTICAL	45.0° (V=1.38)
	HORIZONTAL	58.1° (V=1.814)
	DIAGONAL	68.7° (V=2.268)
9. OPTICAL DISTORTION	<1.0%	
10. TV DISTORTION	<1.0%	
11. RELATIVE ILLUMINATION	>42.3%	
12. CONSTRUCTION	4P+IR FILTER	
13. CHIEF RAY ANGLE	<25°	
14. CUT FREQUENCY AT 50%	650±10nm	
15. THREAD	M6.0X0.35P	
16. IMAGE QUALITY	AXIS	330Lp/mm
	0.7Y	200Lp/mm
17. APPEARANCE QUALITY (Scratch/Dig)	CENTER	20/10
	EDGE	40/20

NO	MODIFY CONTENT	NAME	DATE
1			

ANGLE	RANGE	DIM	UNIT	SCALE
	±0.5°		m	8 : 1
	±0.010		m	
	±0.05		m	
	±0.1		m	

NOTE:

1. 镜头表面不可有油污、灰尘、毛丝等异物。
2. 镜头配VCM锁附高度为 4.7±0.1mm, 扭力为20--60gf.cm。
3. 镜头承受推力为≥2.0kg。
4. 镜头品质参数需符合图中要求。

0.4 mm Pitch, 0.9 mm Height, Board-to-Board / Board-to-FPC Connectors

DF30 Series

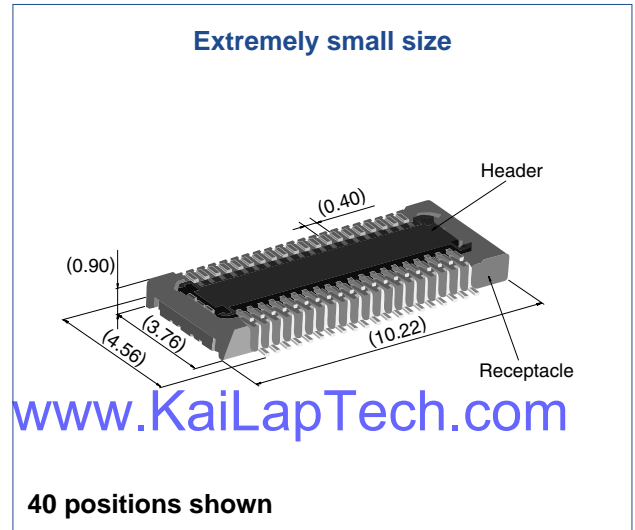
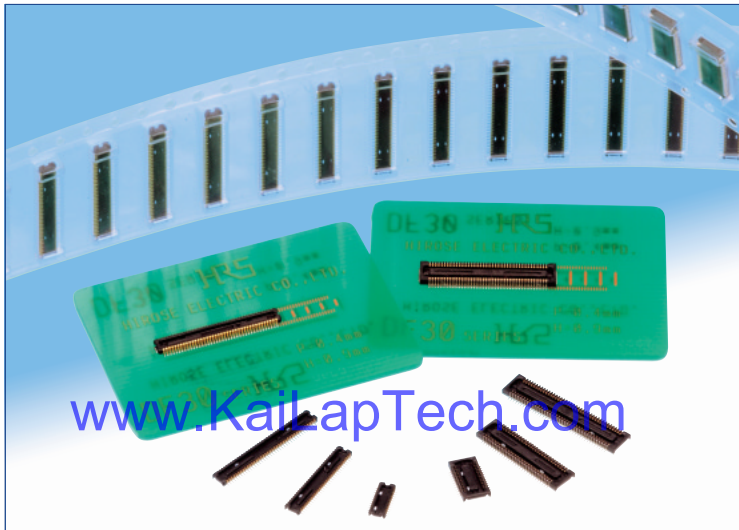

Overview

Continuous miniaturization and increased component density on PCB created demand for extremely low profile connectors. This series is addition of a new extremely low profile connectors to Hirose's wide range of high reliability board-to-board/board-to-FPC connection solutions.

Features

- 1. Contact reliability**
Concentration of the contact's normal forces at the single point assures good contact wipe and electrical reliability, while confirming the fully mated condition with a definite tactile click.
- 2. Self alignment**
Recognizing the difficulties of mating extremely small connectors in limited spaces the connectors will self align in horizontal axis within 0.3 mm.
- 3. Automatic board placement**
Packaged on tape-and-reel the plug and headers have sufficiently large flat areas to allow pick-up with vacuum nozzles of automatic placement equipment.
- 4. Variety of contact positions and styles**
Available in standard contact positions of: 20, 22, 24, 30, 34, 40, 50, 60, 70 and 80 with and without metal fittings. Addition of metal fittings does not affect external dimensions of the connectors. Smaller contact positions are also available.
- 5. Support for continuity test connector**
Connectors which have increased insertion and removal durability are available for continuity tests. Contact your Hirose sales representative for details.

Applications

Cellular phones, PDA's, mobile computers, digital cameras, digital video cameras, and other devices demanding high reliability connections in extremely limited spaces.



Product Specifications

Rating	Rated current 0.3A Rated voltage 30V AC	Operating temperature range : -35°C to 85°C (Note 1) Operating humidity range : Relative humidity 20% to 80%	Storage temperature range -10°C to 60°C (Note 2) Storage humidity range Relative humidity 40% to 70% (Note 2)
--------	--	---	--

Item	Specification	Conditions
1. Insulation resistance	50 MΩ min.	100V DC
2. Withstanding voltage	No flashover or insulation breakdown.	100V AC / one minute
3. Contact resistance	100 mΩ max.	100 mA
4. Vibration	No electrical discontinuity of 1 μs or more	Frequency: 10 to 55 Hz, single amplitude of 0.75mm, 2 hours, 3 axis
5. Humidity	Contact resistance: 100 mΩ max. Insulation resistance: 25 MΩ min.	96 hours at temperature of 40°C±2°C and RH of 90% to 95%
6. Temperature cycle	Contact resistance: 100 mΩ max. Insulation resistance: 50 MΩ min.	Temperature: -55°C→+5°C to +35°C→+85°C→+5°C to +35°C Duration: 30→10→30→10(Minutes) 5 cycles
7. Durability (insertions/withdrawals)	Contact resistance: 100 mΩ max.	50 cycles (Connector for conductivity tests: 500 cycles)
8. Resistance to soldering heat	No deformation of components affecting performance.	Reflow: At the recommended temperature profile Manual soldering: 300°C for 3 seconds

Note 1: Includes temperature rise caused by current flow.

Note 2: The term "storage" refers to products stored for long period of time prior to mounting and use. Operating temperature range and humidity range covers non-conducting condition of installed connectors in storage, shipment or during transportation.

Materials and Finishes

Connectors	Component	Material	Finish	Remarks
Receptacles and Headers	Insulator	LCP	Color : Black	UL94V-0
	Contacts	Phosphor bronze	Gold plated	
	Metal fittings	Phosphor bronze	Tin-copper plated	

Ordering information

Receptacles and Headers

DF30 FC - * DS - 0.4 V (**)

1 2 3 4 5 6 7

① Series name: DF30	⑤ Contact pitch: 0.4 mm
② Configuration FB: With metal fittings, without bosses FC: Without metal fittings, without bosses CJ: Connector for conductivity tests	⑥ Termination section V: Straight SMT
③ Number of positions: 20, 22, 24, 30, 34, 40, 50, 60, 70, 80	⑦ Packaging (81): Embossed tape packaging (5,000 pieces per reel) (82): Embossed tape packaging (1,000 pieces per reel)
④ Connector type DS: Double row receptacle DP: Double row header	

■ Receptacles (without metal fittings)

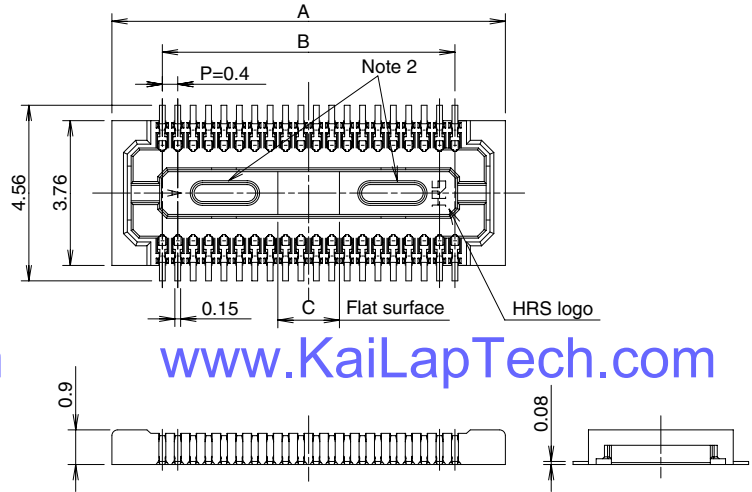
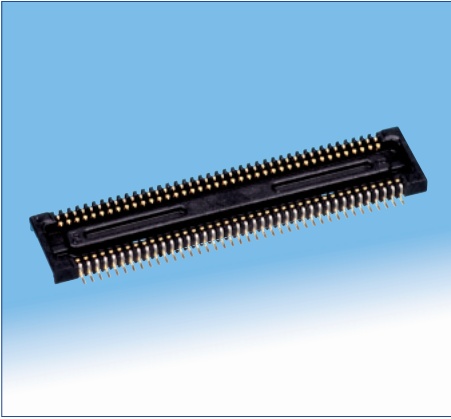

www.KaiLapTech.com

www.KaiLapTech.com

◆ Recommended PCB mounting pattern

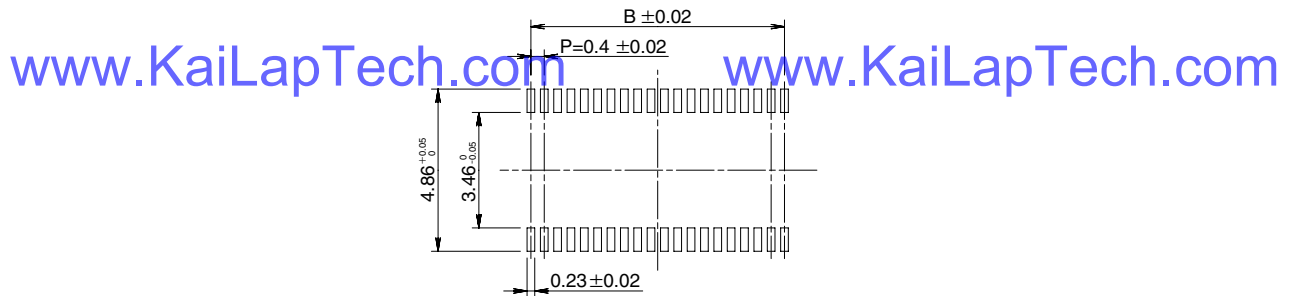

Recommended solder paste thickness: 120 μm

www.KaiLapTech.com

www.KaiLapTech.com

[Specification number] -**, (**)
(81): Embossed tape packaging (5 000 pieces per reel)

* Tolerances non- accumulative.

Unit: mm

Part Number	CL No.	Number of contacts	A	B	C
DF30FC-20DS-0.4V(**)	CL684-1109-8-**	20	6.22	3.6	1.2
DF30FC-22DS-0.4V(**)	CL684-1110-7-**	22	6.62	4.0	1.2
DF30FC-24DS-0.4V(**)	CL684-1111-0-**	24	7.02	4.4	1.2
DF30FC-30DS-0.4V(**)	CL684-1112-2-**	30	8.22	5.6	1.2
DF30FC-34DS-0.4V(**)	CL684-1113-5-**	34	9.02	6.4	1.36
DF30FC-40DS-0.4V(**)	CL684-1078-6-**	40	10.22	7.6	1.6
DF30FC-50DS-0.4V(**)	CL684-1114-8-**	50	12.22	9.6	2.0
DF30FC-60DS-0.4V(**)	CL684-1082-3-**	60	14.22	11.6	2.4
DF30FC-70DS-0.4V(**)	CL684-1115-0-**	70	16.22	13.6	2.8
DF30FC-80DS-0.4V(**)	CL684-1116-3-**	80	18.22	15.6	3.2

Note 1: Order by number of reels.

Note 2: Receptacles with 24 or fewer contacts positions will not have recessed areas.

Product Overview

AR0144CS: CMOS Image Sensor, Digital, Global Shutter, 1.0 MP, 1/4-Inch

For complete documentation, see the data sheet.

The AR0144 is a 1/4-inch 1.0 Mp CMOS digital image sensor with an active-pixel array of 1280H x 800V. It incorporates a new innovative global shutter pixel design optimized for accurate and fast capture of moving scenes. The sensor produces clear, low noise images in both low-light and bright scenes. It includes sophisticated camera functions such as auto exposure control, windowing, row skip mode, column-skip mode, pixel-binning and both video and single frame modes. It is programmable through a simple two-wire serial interface. The AR0144 produces extraordinarily clear, sharp digital pictures, and its ability to capture both continuous video and single frames makes it the perfect choice for a wide range of applications, including scanning and industrial inspection.

Features

- Best Global Shutter Efficiency
- Low Dark Current/Hot Pixels
- High Linear Full Well
- Low Operational Power
- Small Form Factor

Applications

- Barcode Scanning
- 3D Scanning
- Virtual/Augmented Reality
- Positional Tracking
- Gesture Recognition

Benefits

- Improved image quality for fast moving objects
- Total Noise Floor Reduction, SNR Improvement
- High Dynamic Range
- Ideal for battery powered applications
- Ideal for space constrained applications like Handheld Scanners

End Products

- Barcode Scanners
- Head Mounted Displays
- Biometric Scanners
- Virtual Reality/Augmented Reality Glasses
- Drones

www.KaiLapTech.com

www.KaiLapTech.com

www.KaiLapTech.com

www.KaiLapTech.com

Part Electrical Specifications

Product	Pricing (\$/Unit)	Compliance	Status	Type	Megapixels	Frame Rate (fps)	Optical Format	Shutter Type	Pixel Size (µm)	Output Interface	Color	Package Type
AR0144CSSC00SUD20		Pb-free Halide free	Active	CMOS	1MP	60	1/4 Inch	Global Shutter	3.0 x 3.0	Multi	RGB	
AR0144CSSC00SUKA0-CPBR		Pb-free Halide free	Active	CMOS	1MP	60	1/4 Inch	Global Shutter	3.0 x 3.0	Multi	RGB	ODCSP-69
AR0144CSSC00SUKA0-CPBR1		Pb-free Halide free	Active									ODCSP-69
AR0144CSSC00SUKA0-CPBR2		Pb-free Halide free	Active									ODCSP-69
AR0144CSSC00SUKA0-CRBR		Pb-free Halide free	Active	CMOS	1MP	60	1/4 Inch	Global Shutter	3.0 x 3.0	Multi	RGB	ODCSP-69
AR0144CSSC00SUKA0-CRBR1		Pb-free Halide free	Active									ODCSP-69
AR0144CSSC20SUD20		Pb-free Halide free	Active	CMOS	1MP	60	1/4 Inch	Global Shutter	3.0 x 3.0	Multi	RGB	
AR0144CSSC20SUKA0-CPBR		Pb-free Halide free	Active	CMOS	1MP	60	1/4 Inch	Global Shutter	3.0 x 3.0	Multi	RGB	ODCSP-69
AR0144CSSC20SUKA0-CRBR		Pb-free Halide free	Active	CMOS	1MP	60	1/4 Inch	Global Shutter	3.0 x 3.0	Multi	RGB	ODCSP-69
AR0144CSSM00SUD20		Pb-free Halide free	Active	CMOS	1MP	60	1/4 Inch	Global Shutter	3.0 x 3.0	Multi	Mono	
AR0144CSSM00SUKA0-CPBR		Pb-free Halide free	Active	CMOS	1MP	60	1/4 Inch	Global Shutter	3.0 x 3.0	Multi	Mono	ODCSP-69
AR0144CSSM00SUKA0-CPBR1		Pb-free Halide free	Active									ODCSP-69
AR0144CSSM00SUKA0-CPBR2		Pb-free Halide free	Active									ODCSP-69
AR0144CSSM00SUKA0-CRBR		Pb-free Halide free	Active	CMOS	1MP	60	1/4 Inch	Global Shutter	3.0 x 3.0	Multi	Mono	ODCSP-69
AR0144CSSM20SUD20		Pb-free Halide free	Active	CMOS	1MP	60	1/4 Inch	Global Shutter	3.0 x 3.0	Multi	Mono	
AR0144CSSM20SUKA0-CPBR		Pb-free Halide free	Active	CMOS	1MP	60	1/4 Inch	Global Shutter	3.0 x 3.0	Multi	Mono	ODCSP-69
AR0144CSSM20SUKA0-CPBR1		Pb-free Halide free	Active	CMOS	1MP	60	1/4 Inch	Global Shutter	3.0 x 3.0	Multi	Mono	ODCSP-69
AR0144CSSM20SUKA0-CRBR		Pb-free Halide free	Active	CMOS	1MP	60	1/4 Inch	Global Shutter	3.0 x 3.0	Multi	Mono	ODCSP-69
AR0144CSSM20SUKA0-CRBR1		Pb-free Halide free	Active	CMOS	1MP	60	1/4 inch	Global Shutter	3.0 x 3.0	Multi	Mono	ODCSP-69
AR0144CSSM28SUD20		Pb-free Halide free	Active	CMOS	1MP	60	1/4 Inch	Global Shutter	3.0 x 3.0	Multi	Mono	
AR0144CSSM28SUKA0-CPBR		Pb-free Halide free	Product P review									ODCSP-69

For more information please contact your local sales support at www.onsemi.com.

Created on: 6/17/2020



Camera Module Pinout Definition Reference Chart

OmniVision	Sony	Samsung	On-Semi	Aptina	Himax	GalaxyCore	PixArt	SmartSens	Sensors
Pin Signal		Description							
DGND GND		ground for digital circuit							
AGND		ground for analog circuit							
PCLK DCK		DVP PCLK output							
XCLR PWDN XSHUTDOWN STANDBY		power down active high with internal pull-down resistor							
MCLK XVCLK XCLK INCK		system input clock							
RESET RST		reset active low with internal pull-up resistor							
NC NULL		no connect							
SDA SIO_D SIOD		SCCB data							
SCL SIO_C SIOC		SCCB input clock							
VSYNC XVS FSYNC		DVP VSYNC output							
HREF XHS		DVP HREF output							
DOVDD		power for I/O circuit							
AFVDD		power for VCM circuit							
AVDD		power for analog circuit							
DVDD		power for digital circuit							
STROBE FSTROBE		strobe output							
FSIN		synchronize the VSYNC signal from the other sensor							
SID		SCCB last bit ID input							
ILPWM		mechanical shutter output indicator							
FREQ		frame exposure / mechanical shutter							
GPIO		general purpose inputs							
SLASEL		I2C slave address select							
AFEN		CEN chip enable active high on VCM driver IC							
MIPI Interface									
MDN0 DN0 MD0N DATA_N DMO1N		MIPI 1st data lane negative output							
MDP0 DP0 MD0P DATA_P DMO1P		MIPI 1st data lane positive output							
MDN1 DN1 MD1N DATA2_N DMO2N		MIPI 2nd data lane negative output							
MDP1 DP1 MD1P DATA2_P DMO2P		MIPI 2nd data lane positive output							
MDN2 DN2 MD2N DATA3_N DMO3N		MIPI 3rd data lane negative output							
MDP2 DP2 MD2P DATA3_P DMO3P		MIPI 3rd data lane positive output							
MDN3 DN3 MD3N DATA4_N DMO4N		MIPI 4th data lane negative output							
MDP3 DP3 MD3P DATA4_P DMO4P		MIPI 4th data lane positive output							
MCN CLKN CLK_N DCKN		MIPI clock negative output							
MCP CLKP MCP CLK_P DCKN		MIPI clock positive output							
DVP Parallel Interface									
D0 DO0 Y0		DVP data output port 0							
D1 DO1 Y1		DVP data output port 1							
D2 DO2 Y2		DVP data output port 2							
D3 DO3 Y3		DVP data output port 3							
D4 DO4 Y4		DVP data output port 4							
D5 DO5 Y5		DVP data output port 5							
D6 DO6 Y6		DVP data output port 6							
D7 DO7 Y7		DVP data output port 7							
D8 DO8 Y8		DVP data output port 8							
D9 DO9 Y9		DVP data output port 9							
D10 DO10 Y10		DVP data output port 10							
D11 DO11 Y11		DVP data output port 11							



your **BEST** camera module partner

Cameras Applications



www.KaiLapTech.com



www.KaiLapTech.com



www.KaiLapTech.com

www.KaiLapTech.com



www.KaiLapTech.com



www.KaiLapTech.com





Camera Reliability Test

Reliability Inspection Item		Testing Method	Acceptance Criteria	
Category	Item			
Environmental	Storage Temperature	High 60°C 96 Hours	Temperature Chamber	No Abnormal Situation
		Low -20°C 96 Hours	Temperature Chamber	No Abnormal Situation
	Operation Temperature	High 60°C 24 Hours	Temperature Chamber	No Abnormal Situation
		Low -20°C 24 Hours	Temperature Chamber	No Abnormal Situation
	Humidity	60°C 80% 24 Hours	Temperature Chamber	No Abnormal Situation
	Thermal Shock	High 60°C 0.5 Hours Low -20°C 0.5 Hours Cycling in 24 Hours	Temperature Chamber	No Abnormal Situation
Physical	Drop Test (Free Falling)	Without Package 60cm	10 Times on Wood Floor	Electrically Functional
		With Package 60cm	10 Times on Wood Floor	Electrically Functional
	Vibration Test	50Hz X-Axis 2mm 30min	Vibration Table	Electrically Functional
		50Hz Y-Axis 2mm 30min	Vibration Table	Electrically Functional
		50Hz Z-Axis 2mm 30min	Vibration Table	Electrically Functional
Cable Tensile Strength Test	Loading Weight 4 kg 60 Seconds Cycling in 24 Hours	Tensile Testing Machine	Electrically Functional	
Electrical	ESD Test	Contact Discharge 2 KV	ESD Testing Machine	Electrically Functional
		Air Discharge 4 KV	ESD Testing Machine	Electrically Functional
	Aging Test	On/Off 30 Seconds Cycling in 24 Hours	Power Switch	Electrically Functional
	USB Connector	On/Off 250 Times	Plug and Unplug	Electrically Functional





Inspection Item		Inspection Method	Standard of Inspection	
Category	Item			
Appearance	FPC/ PCB	Color	The Naked Eye	Major Difference is Not Allowed.
		Be Torn/Chopped	The Naked Eye	Copper Crack Exposure is Not Allowed.
		Marking	The Naked Eye	Clear, Recognizable (Within 30cm Distance)
	Holder	Scratches	The Naked Eye	The Inside Crack Exposure is Not Allowed
		Gap	The Naked Eye	Meet the Height Standard
		Screw	The Naked Eye	Make Sure Screws Are Presented (If Any)
		Damage	The Naked Eye	The Inside Crack Exposure is Not Allowed
	Lens	Scratch	The Naked Eye	No Effect On Resolution Standard
		Contamination	The Naked Eye	No Effect On Resolution Standard
		Oil Film	The Naked Eye	No Effect On Resolution Standard
		Cover Tape	The Naked Eye	No Issue On Appearance.
	Function	Image	No Communication	Test Board
Bright Pixel			Black Board	Not Allowed In the Image Center
Dark Pixel			White board	Not Allowed In the Image Center
Blurry			The Naked Eye	Not Allowed
No Image			The Naked Eye	Not Allowed
Vertical Line			The Naked Eye	Not Allowed
Horizontal Line			The Naked Eye	Not Allowed
Light Leakage			The Naked Eye	Not Allowed
Blinking Image			The Naked Eye	Not Allowed
Bruise			Inspection Jig	Not Allowed
Resolution			Chart	Follows Outgoing Inspection Chart Standard
Color			The Naked Eye	No Issue
Noise			The Naked Eye	Not Allowed
Corner Dark			The Naked Eye	Less Than 100px By 100px
Color Resolution			The Naked Eye	No Issue
Dimension	Height	The Naked Eye	Follows Approval Data Sheet	
	Width	The Naked Eye	Follows Approval Data Sheet	
	Length	The Naked Eye	Follows Approval Data Sheet	
	Overall	The Naked Eye	Follows Approval Data Sheet	



KLT Package Solutions

KLT Camera Module



Complete with Lens Protection Film

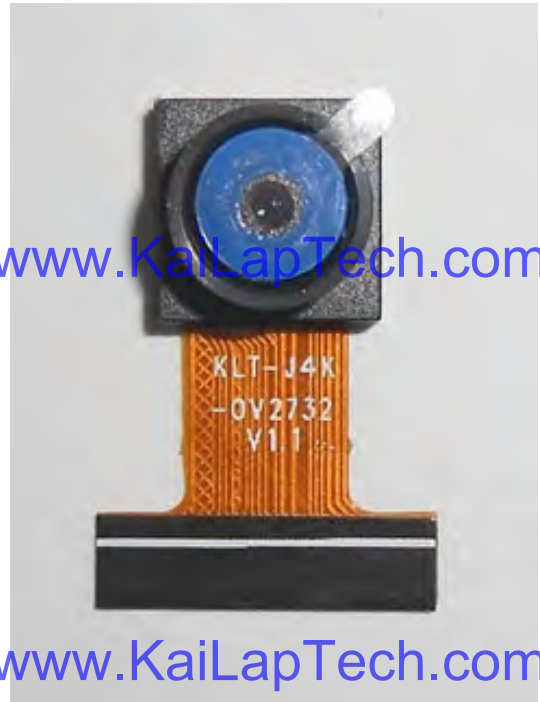

Tray with Grid and Space



Place Cameras on the Tray





Camera Modules Package Solution

Full Tray of Cameras



Cover Tray with Lid



Put Tray into Anti-Static Bag



Vacuum the Anti-Static Bag

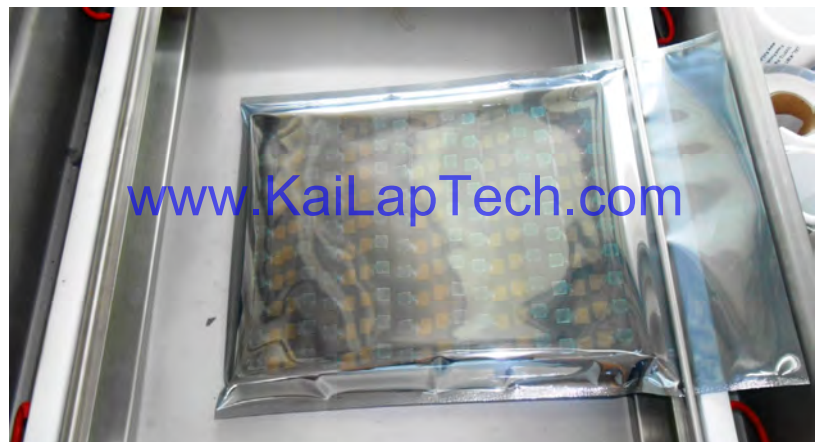



Camera Modules Package Solution

Sealed Vacuum Bag with Labels

- 1. Model and Description 2. Quantity 3. Shipping Date 4. Caution**





CMOS CAMERA MODULES



your BEST camera module partner

Large Order Package Solution

Place Foam Sheets Between Trays

Foam Sheets are Slightly Larger than Trays



www.KaiLapTech.com

www.KaiLapTech.com

Place Foam Sheets and Trays into Box

Foam Sheets are Tightly Fitting Box



www.KaiLapTech.com sales@KaiLapTech.com Tel: (852) 6908 1256 Fax: (852) 3017 6778

All rights reserved @ Kai Lap Technologies Group Ltd. Specifications subject to change without notice.



CMOS CAMERA MODULES



your BEST camera module partner

Small Order Package Solution

Place Foam Sheets and Trays into Small Box



www.KaiLapTech.com

Package in Small Box for Shipment

Foam Sheets are Nicely Fitting the Small Box



www.KaiLapTech.com

Place Small Boxes into Larger Box



www.KaiLapTech.com sales@KaiLapTech.com Tel: (852) 6908 1256 Fax: (852) 3017 6778

All rights reserved @ Kai Lap Technologies Group Ltd. Specifications subject to change without notice.



your BEST camera module partner

Carbon Box Package Solution

Seal the Carbon Box

Final Package Labelled Box



Carbon Box Ready for Shipment

1. Delivery Address and Phone No.
2. Box No. and Ship Date
3. Fragile Caution



Sample Order Package Solution

Place Sample into Small Anti-Static Bag



Place Connectors into Small Ant-Static Bag



Sample Labels on the Small Bag

1. Camera Module or Connector Model 2. Shipping Date and Quantity 3. Caution





Connectors Large Order Package Solution

Connectors in a Wheel



Label Connectors in the Wheel



The Wheel is Perfectly Fitting the Box



Connectors Box Ready for Shipment



Company Kai Lap Technologies (KLT)

Kai Lap Technologies Group Limited. (KLT) was established in 2009, a next-generation technology driven manufacturer specialized in research, design, and produce of audio and video products. KLT is occupying 20,000 square feet automated plants with 100 employees of annual throughput 30,000,000 units cameras.

KLT provides OEM, ODM design, contract manufacturing, and builds the camera products. You may provide the requirements to us, even with a hand draft, our sales and engineering work together to meet your needs. We consider ourselves your last-term partner in developing practical and innovative solutions.

Our team covers everything from initial concept development to mass produced product. KLT specializes in customized camera design, raw material, electronic engineering, firmware/software development, product testing, and packing design. Our experienced strategic supply systems offer a robust and dependable manufacturing capacity for orders of various sizes.

www.KaiLapTech.com

www.KaiLapTech.com



Limited Warranty

KLT provides the following limited warranty if you purchased the Product(s) directly from KLT company or from KLT's website, www.KaiLapTech.com. Product(s) purchased from other sellers or sources are not covered by this Limited Warranty. KLT guarantees that the Product(s) will be free from defects in materials and workmanship under normal use for a period of one (1) year from the date you receive the product ("Warranty Period").

For all Product(s) that contain or develop material defects in materials or workmanship during the Warranty Period, KLT will, at its sole option, either: (i) repair the Product(s); (ii) replace the Product(s) with a new or refurbished Product(s) (replacement Product(s) being of identical model or functional equivalent); or (iii) provide you a refund of the price you paid for the Product(s).

This Limited Warranty of KLT is solely limited to repair and/or replacement on the terms set forth above. KLT is not reliable or responsible for any subsequent events.





CMOS CAMERA MODULES



your BEST camera module partner

KLT Strength

Powerful Factory



www.KaiLapTech.com

www.KaiLapTech.com

Professional Service



www.KaiLapTech.com

www.KaiLapTech.com

Promised Delivery



www.KaiLapTech.com

www.KaiLapTech.com



www.KaiLapTech.com sales@KaiLapTech.com Tel: (852) 6908 1256 Fax: (852) 3017 6778

All rights reserved @ Kai Lap Technologies Group Ltd. Specifications subject to change without notice.